

**OUTDOOR
ARCHITECTURAL
FLUORESCENT LUMINAIRES**

SURFACE END MOUNT

ARIDA-WF6

LTT / T5 /
T5HO / T8 / T8HO / T12HO

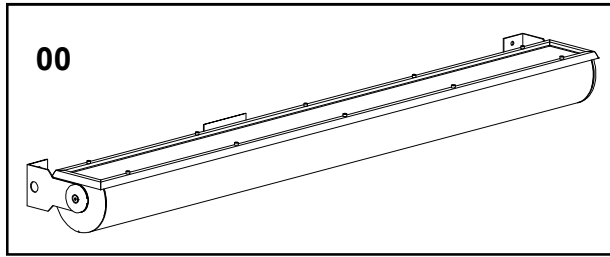

00

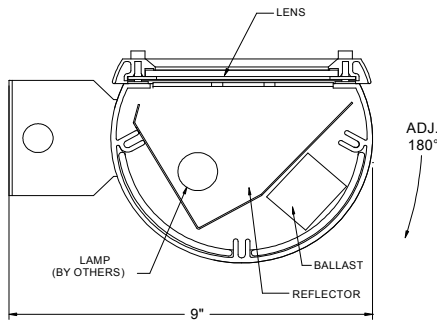
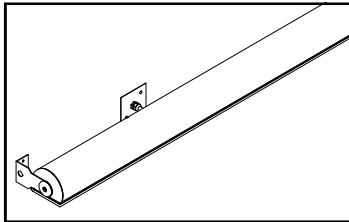

Nominal Luminaire Length	4'	8'
Dimension 'A'	50-00"	98-00"
Dimension 'B'	48-00"	96-00"

SPECIFICATIONS

Housing: Extruded aluminum with single piece die-cast aluminum end caps welded to the extruded housing.

Mounting Hardware: The mounting brackets are attached to the end plates allows for easy maintenance and adjustment. Fixture mounts to a standard 4-0 J-box (by others). Additional support is required.

Electrical: Ballasts are integral, electronic, thermally protected, with a power factor of greater than 90%, a THD of less than 10% and a minimum starting temperature of 20°F. T8HO and T12HO ballasts are integral and magnetic with a minimum starting temperature of minus 20°F. Fixtures are pre-wired and tested at the factory prior to shipment.

Lens: Clear acrylic is standard. Optional prismatic acrylic, colored acrylic or polycarbonate lenses are available.

LIGHT DIRECTION

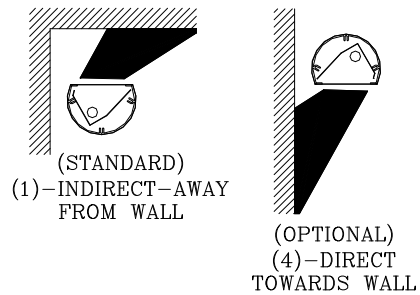

DIMENSIONS

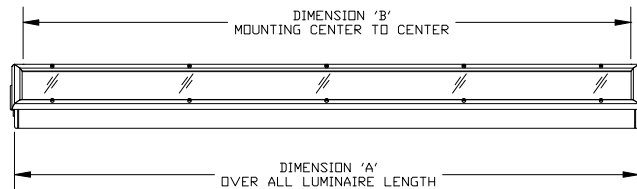

MOUNTING BRACKET

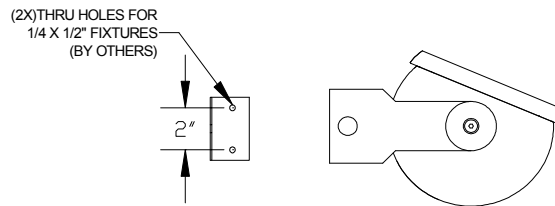

Reflector: CAD designed, die-formed and constructed of 95% reflective, specular, peened and anodized aluminum providing for clean, even distribution with no streaks or striations.

Finish: All surfaces are pretreated with a multi-stage phosphate wash and powder coated to a minimum of 3 mil thickness. Standard finishes are Textured White, Black, Natural, Bronze, Sandstone and Verdi. Twenty additional standard colors are available. Please refer to the Insight color palette. Custom colors can be specified.

Labels: UL / CUL approved for Wet locations.

Insight Lighting reserves the right to change specifications without notice due to product improvements.



INSIGHT

Rio Rancho, NM 87144
TEL: 505 345-0888
www.insightlighting.com

WF6-00-01 20OCT09









**OUTDOOR
ARCHITECTURAL
FLUORESCENT LUMINAIRES**

SURFACE END MOUNT

ARIDA-WF6

LTT / T5 /
T5HO / T8 / T8HO / T12HO

FIXTURE	MOUNTING TYPE	REFLECTOR TYPE	VOLTS	FINISH	OPTIONS
6" Linear Fluorescent (WF6)	00 Surface Cradle Mount	SA(1) Single Lamp Asymmetric 	1. 120V	TW Textured White TBL Textured Black TBR Textured Bronze TN Textured Natural TS Textured Sandstone TLB Textured Light Bronze	WCF Colored Lens (Contact Factory)
		SS Single Lamp Symmetric 	2. 277V		
Integral Electronic Ballast	Single Luminaires (8' Max)	TA(D) Twin Lamp Asymmetric 	7. 347V*	SF Specify Finish (See Color Chart) CC Custom Color (Contact Factory)	PC Clear Polycarbonate PL Prismatic Acrylic Lens WVS Solid Cutoff Visor BP-LT Low Temperature Battery Pack (-18° to 55° C, Contact Factory) DM Dimming Ballast (Contact Factory)
		TS Twin Lamp Symmetric 	*Contact Factory		
		RA(D) Three lamp Asymmetric 			
		RS Three Lamp Symmetric 			
		(D) = Light Direction			

ORDERING EXAMPLE: WF6 / 00 / TA(1) / T5HO / 54W / 8' / 2 / TN / PC

Reflector Types		(SA) Single Lamp Asymmetric	(TA) Two Lamp Asymmetric	(RA) Three amp Asymmetric	(SS) Single Lamp Symmetric	(TS) Two Lamp Symmetric	(RS) Three Lamp Symmetric
Fixture length	Lamp length	One Lamp	Two Lamp	Three Lamp	One Lamp	Two Lamp	Three Lamp
4' & 8'	2'		LTT40			LTT40	
4' & 8'	2'		LTT50			LTT50	
4' & 8'	2'		LTT55			LTT55	
4' & 8'	2'	LTT80			LTT80		
4' & 8'	4'		T8 32W			T8 32W	
4' & 8'	4'		T5 28W	T5 28W		T5 28W	T5 28W
4' & 8'	4'		T5 HO 54W	T5 HO 54W		T5 HO 54W	T5 HO 54W
4' & 8'	4'		T8 HO 44W			T8 HO 44W	
8'	8'		T8 HO 86W			T8 HO 86W	
4' & 8'	4'	T12 HO 60W			T12HO 60W		
8'	8'	T12 HO 110W			T12 HO 110W		

PREFIX	MOUNTING	REFLECTOR	LAMP TYPE	WATTAGE	FIXTURE LENGTH	VOLTS	FINISH	OPTIONS
WF6	00							

TYPE: _____
 JOB NAME: _____
 APPROVED: _____



INSIGHT

Rio Rancho, NM 87144
 TEL: 505 345-0888
 www.insightlighting.com

